



# TRADITIONAL GAS FIREPLACES

REGENCY-FIRE.COM



# WHY CHOOSE REGENCY?

At Regency, our past 40 years have been focused on providing a high-level of service while building high-quality and reliable products that our customers can enjoy for years to come.

## HIGH-QUALITY

*Producing a high-quality product has been at the very heart of what we do from when that very first stove rolled off the production line over 40 years ago to today. We are ever-focused on producing quality products for our customers that will last for years to come.*

## BEST WARRANTY

*A fireplace should be reliable and should work right the first time it is used, and the 1,000<sup>th</sup>. A core part of our business is making sure that we are building long-lasting, durable, high-quality products; we back-up that commitment with the industry's best warranty on all our products.*

## COST-EFFICIENT

*Never before have home heating costs been higher. Turn your furnace way down and zone heat with our beautiful, reliable and convenient Regency products. Not only can you cut your fuel bills in half, but you'll be able to enjoy the timeless comfort of a Regency fire.*

***Why Regency? Because it's more than a fireplace!***



# TABLE OF CONTENTS

Regency Grandview Gas Fireplaces	
<b>G800EC, G800C</b>	<b>06</b>
<b>G600EC, G600C</b>	<b>08</b>
Regency Bellavista® Gas Fireplaces	
<b>B41XTCE, B36XTCE</b>	<b>10</b>
Regency Panorama® Gas Fireplaces	
<b>P36, P36E, P36D</b>	<b>12</b>
<b>P33, P33E, P33CE</b>	<b>14</b>
Regency Excalibur® Gas Fireplace	
<b>P90E</b>	<b>16</b>
Design Choices & Options	<b>18</b>
Specifications	<b>22</b>



# INTRODUCING REGENCY'S NEWEST LINE GRANDVIEW GAS FIREPLACES



G800EC shown with oak log set and rustic brown brick panels in a cool wall clean front install using wallpaper.

## *One Fireplace, Unlimited Possibilities*

Designed using customer feedback, the Regency Grandview gas fireplace is our most flexible fireplace yet! The Grandview series offers stunning flame pictures and full customization, allowing homeowners to pick and choose the accessories and elements that best suit their style – with over 960 combinations, there is a Grandview for every home and every style.

Choose from traditional installation or utilize Regency's patented Cool Wall System to provide ultimate design flexibility. The Regency Cool Wall system allows the use of virtually any material to the edge of the fireplace or the placement of TVs or artwork directly above the fire; without any limitations.

### **COOL WALL SYSTEM ADVANTAGES**

- Place a TV above the fireplace without it getting damaged
- Hang artwork without fear of warping
- Paint will not discolor, drywall will not crack
- No internal fans required
- Use any finish right to the edge of the fire, even wood or wallpaper

# OPTIONS & ACCESSORIES FOR GRANDVIEW

## CHOOSE YOUR LOOK

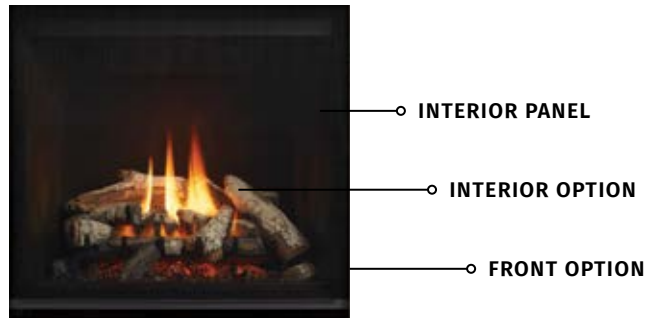

### MULTIPLE INTERIOR PANELS



*Rustic Brown Brick Panels*



*Herringbone - Rustic Brown Brick Panels*



*Volcanic Black Brick Panels*



*Castlestone*

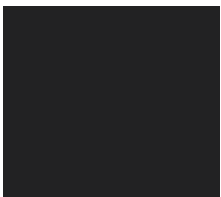

*Painted Black Steel Panels*



*Black Enamel Reflective Panels*

### MULTIPLE INTERIOR OPTIONS



*Birch Log Set*



*Oak Log Set*



*Driftwood Log Set*



*Crushed Glass - Ginger*



*Crushed Glass - Coal Black*



*Crushed Glass - Iceberg*



*Volcanic Stones*

### MULTIPLE FRONT OPTIONS



*Clean Front Finishing Trim*



*Outside Finishing Trim*



*Faceplate*

#### FACEPLATE AVAILABLE IN THREE COLORS:



*Black*



*Brushed Nickel*



*Antique Copper*



G800EC shown with birch log set and volcanic black brick liner panels.

## REGENCY GRANDVIEW

## G800EC • G800C *Medium Gas Fireplaces*



G800EC/G800C - Birch log set and castlestone brick panels



G800EC/G800C - Iceberg crushed glass, volcanic stones and black steel panels



G800EC/G800C - Oak log set and herringbone brick panels

### YOUR FIREPLACE, YOUR WAY

Choose stunning flame picture, choose your accessories, and create a one-of-a-kind fireplace. The Regency Grandview G800 is the first of our Grandview series of gas fireplaces that are designed to maximize choice and customization.

SPECIFICATIONS	G800EC		G800C	
	NATURAL GAS	PROPANE	NATURAL GAS	PROPANE
Input (BTU)	27,000	25,500	27,000	26,500
Turn down to (BTU)	15,000	21,000	15,000	14,500
Efficiency (steady state)	65.20%	68.16%	61.12%	63.62%
EnerGuide Rating (Canada only)	53.58%	57.74%	51.86%	53.64%

#### DIMENSIONS

Viewing Area	800 sq. in.
Width	35-7/8"
Height	35-7/8"
Depth	16-7/8"

For detailed specifications please see page 22.



*G800C shown with birch log set, herringbone brick panels and brushed nickel faceplate.*



*G800EC/G800C - Iceberg crushed glass, black steel panels and black faceplate*



*G800EC/G800C - Birch log set with brown brick panels and antique copper faceplate*



*G800EC/G800C - Driftwood log set and volcanic black brick panels and brushed nickel faceplate*

## FEATURES

- Clean front design
- Largest viewing area in its class
- Standard top down and ember-bed lighting
- Integrated safety screen
- Ceramic glass
- Standing Pilot (Direct Spark Ignition - G800C, available in USA only)
- Flame height adjustment control
- Proflame II GTMF remote control (G800EC only)
- Electronic ignition (G800EC)
- Rear or top vent for versatile installations
- Natural gas
- Limited lifetime warranty

## OPTIONS

- Choose from a log grate and traditional style log package or contemporary crystal tray
- Cool Wall system to allow for any finishing material right to the edge of the fireplace
- Brick panels in a variety of colors and designs
- Inner reflective panels in black enamel
- Inner painted black steel panels
- Surrounds in various colors
- Finishing trims for easy finishing around the fireplace
- Variable speed blower
- Chase vent (cool wall installations)
- Propane conversion kit
- ON/OFF remote control (G800C)
- AstroCap® venting system
- Heat Wave™ power duct kit



G600EC shown with birch log set and reflective enamel inner panels.

## REGENCY GRANDVIEW | G600EC • G600C *Small Gas Fireplaces*



G600EC/G600C - Oak log set and rustic brown brick panels



G600EC/G600C - Oak log set and castlestone brick panels



G600EC/G600C - Birch log set, herringbone brick panels and black faceplate

### SMALL FIREPLACE, BIG FLAME

Experience the stunning flame pictures, full customization, and design flexibility of the Grandview series, but now smaller! The G600 offers all the benefits of our Grandview series but in a more compact frame – suitable for smaller spaces or zone heating.

SPECIFICATIONS	G600EC		G600C	
	NATURAL GAS	PROPANE	NATURAL GAS	PROPANE
Input (BTU)	21,000	20,500	21,000	20,500
Turn down to (BTU)	11,500	16,500	11,500	11,000
Efficiency (steady state)	71.17%	72.80%	71.18%	72.71%
EnerGuide Rating (Canada only)	65.04%	70.65%	62.13%	64.64%

#### DIMENSIONS

Viewing Area	600 sq. in.
Width	31-7/8"
Height	29-7/8"
Depth	14-5/8"

For detailed specifications please see page 23.





*G600C shown with coal black crushed glass and painted black steel panels installed with a clean front finish using the cool wall system and chase vent.*



*G600EC/G600C - Ginger crushed glass and antique copper faceplate*



*G600EC/G600C - Iceberg crushed glass, volcanic stones and brushed nickel faceplate*



*G600EC/G600C - Driftwood log set and black steel panels*

## FEATURES

- Clean front design
- Largest viewing area in its class
- Integrated safety screen
- Ceramic glass
- Flame height adjustment control
- Standing Pilot (Direct Spark Ignition - G600C, available in USA only)
- Proflame II GTMF remote control (G600EC)
- Electronic ignition (G600EC)
- Rear or top vent for versatile installations
- Natural gas
- Limited lifetime warranty

## OPTIONS

- Choose from a log grate and traditional style log package or contemporary crystal tray
- Cool Wall system to allow for any finishing material right to the edge of the fireplace
- Brick panels in a variety of colors and designs
- Inner reflective panels in black enamel
- Inner painted black steel panels
- Surrounds in various colors
- Finishing trims for easy finishing around the fireplace
- Variable speed blower
- Chase vent (cool wall installations)
- Propane conversion kit
- ON/OFF remote control (G600C)
- AstroCap® venting system



B36XTCE shown with rustic brown brick panels and integrated safety screen.

## REGENCY BELLAVISTA® | B36XTCE • B41XTCE Large Gas Fireplaces

### EXCEPTIONAL FLAME

The B36XTCE model features a bold flame and log package behind a 652 sq.in. viewing area that provides up to 31,000 BTU's of comforting heat. Quality workmanship is evident in Bellavista's finishes, custom accessories, and safety tested ceramic glass.

### EXPANSIVE VIEWING AREA

With its impressive viewing area and artistic fire presentation, the Bellavista® creates beautiful gathering spaces. The B41XTCE features a flush face design for a frameless display while offering a range of trim finishes to suit any style and environment.

SPECIFICATIONS (NATURAL GAS)*	B36XTCE	B41XTCE
Input (BTU)	31,000	42,500
Turn down to (BTU)	21,500	30,000
Efficiency (steady state)	70.56%	72.76%
EnerGuide Rating (Canada only)	65.90%	68.15%

DIMENSIONS		
Viewing Area	652 sq. in.	840 sq. in.
Width	40-5/8"	46-11/16"
Height	38-1/16"	44-1/4"
Depth	23-5/8"	26-3/16"

\* For propane (LP) specs please see page 24.  
For detailed specifications please see pages 24-27.



*B41XTCE with old town red brick panels and integrated safety screen.*

## FEATURES

- Natural gas or propane
- Safety screen
- Ceramic glass
- Log set with embers
- Fire grate
- Flame height adjustment control
- Proflame I GTMF remote control
- Electronic ignition with SureFire™ switch
- Top or rear vent for versatile installations
- Limited lifetime warranty

## OPTIONS

- Brick panels in a variety of colors and designs
- Inner reflective panels in black enamel
- Ember upgrade kit
- Wall thermostat
- Variable speed blower
- Vertical or horizontal vent terminations
- AstroCap® venting system



*P36 shown with Vignette faceplate in black, Vignette finishing trim, rustic brown brick panels and integrated safety screen.*

## REGENCY PANORAMA® | P36 · P36E · P36D



*Black Louvers*



*Vignette Faceplate - Tuscan Sunset*



*Vignette Faceplate - Platinum*

### POPULAR SIZE

Our most popular fireplace size is available in both slim and deep box designs to deliver a beautiful fire and efficient heat to most common family rooms, dens and bedrooms.

### VERSATILE STYLE

With the versatile Panorama P36, you can turn a traditional fireplace into a dynamic part of your home decor. Customize with warm finishes, screen doors and decorative accents - make it your Regency, right down to the last detail.

SPECIFICATIONS (NATURAL GAS)*	P36	P36E	P36D
Input (BTU)	30,000	29,500	30,000
Turn down to (BTU)	15,500	19,500	15,500
Efficiency (steady state)	70.55%	72.88%	71.26%
EnerGuide Rating (Canada only)	62.36%	66.86%	63.89%

DIMENSIONS			
Viewing Area	451 sq. in.	451 sq. in.	451 sq. in.
Width	36"	36"	36"
Height	30-1/2"	30-1/2"	30-1/2"
Depth	12-3/4"	12-3/4"	17-1/8"

\* For propane (LP) specs please see page 24.  
For detailed specifications please see pages 24-27.



P36 shown with Vignette faceplate in black chrome, Vignette finishing trim, rustic brown brick panels and integrated safety screen.



Vignette Faceplate - Black  
Vignette Door Inlay - Black



Vignette Faceplate - Black  
Vignette Door Inlay - Black Chrome



Vignette Faceplate - Black  
Vignette Door Inlay - Tuscan Sunset

## FEATURES

- Natural gas
- Safety screen
- Ceramic glass
- Log set with embers
- Fire grate
- Flame height adjustment control
- Proflame GTMF remote control
- Electronic ignition (P36E)
- Standing Pilot (Direct spark ignition - P36/P36D, available in USA only)
- Limited lifetime warranty

## OPTIONS

- Vignette surrounds in various colors
- Vignette door inlays in various colors
- Vignette finishing trim
- Brick panels in a variety of colors and designs
- Inner reflective panels in black enamel
- Ember upgrade kit
- Black louvers & mesh guard
- Variable speed blower
- Wall thermostat
- Propane conversion kit
- Vertical or horizontal vent terminations
- Heat Wave™ power duct kit
- AstroCap® venting system
- 3-sided finishing trim (when using black louvers)



P33 shown with Vignette faceplate in black, Vignette finishing trim, rustic brown brick panels and integrated safety screen.

## REGENCY PANORAMA® | P33 · P33E · P33CE *Small Gas Fireplaces*



P33/P33E Black Louvers



P33/P33E Vignette Faceplate - Tuscan Sunset



P33/P33E Vignette Faceplate - Platinum

### TRUE FLUSH FINISHING

True flush finishing provides an unobstructed view of the fire in Regency's Panorama™ P33CE gas fireplace. As a focal point in small to medium-sized spaces, the P33CE embodies the complete fireplace experience with an artist sculpted ceramic log set and glowing embers.

### COMPACT DESIGN

Measuring just 12-3/4 inches in depth, the slim design of the P33/P33E delivers all the features of the Panorama collection, and just the right amount of heat output, in a versatile, compact design.

SPECIFICATIONS (NATURAL GAS)*	P33	P33E	P33CE
Input (BTU)	20,000	20,000	20,000
Turn down to (BTU)	14,000	14,000	14,000
Efficiency (steady state)	72.57%	68.28%	68.28%
EnerGuide Rating (Canada only)	66.01%	66.49%	66.49%

DIMENSIONS			
Viewing Area	416 sq.in.	416 sq.in.	416 sq.in.
Width	33"	33"	34-9/16"
Height	29"	29"	29-1/4"
Depth	12-3/4"	12-3/4"	16"

\* For propane (LP) specs please see page 24.  
For detailed specifications please see pages 24-27.



P33CE shown with birch log set.



P33 - Vignette Faceplate - Black Chrome



P33 - Vignette Faceplate - Black  
Vignette Door Inlay - Black Chrome



P33 - Vignette Faceplate - Black  
Vignette Door Inlay - Tuscan Sunset

## FEATURES

- Natural gas
- Safety screen
- Ceramic glass
- Log set with embers
- Fire grate
- Flame height adjustment control
- Proflame I GTMF remote control
- Direct spark ignition (P33, available in USA only)
- Electronic ignition (P33E/P33CE)
- 45° flue for versatile installations
- Limited lifetime warranty

## OPTIONS

- Vignette surrounds in various colors (P33/P33E)
- Vignette door inlays in various colors (P33/P33E)
- Vignette finishing trim (P33/P33E)
- Black louvers (P33/P33E)
- Brick panels in various colors and designs
- Inner reflective panels in black enamel
- Ember upgrade kit
- Wall thermostat
- Variable speed blower
- Vertical or horizontal vent terminations
- Propane conversion kit
- Heat Wave™ power duct kit
- AstroCap® venting system
- 3-sided finishing trim (when using black louvers)



P90 shown with herringbone brick panels and double door inlay with integrated safety screen.

## REGENCY EXCALIBUR® | P90E Gas Fireplace

### TIMELESS ARCH DESIGN

The gentle arched design of this product provides the perfect backdrop for Regency's beautiful flames. Glowing embers and realistic split logs molded by an artist from real wood create the experience of an authentic-looking wood burning fire.

SPECIFICATIONS (NATURAL GAS)*	P90
Input (BTU)	35,000
Turn down to (BTU)	23,500
Efficiency (steady state)	76.07%
EnerGuide Rating (Canada only)	71.36%

DIMENSIONS	
Viewing Area	455 sq. in.
Width	37"
Height	29-1/4"
Depth	19-1/4"

\* For propane (LP) specs please see page 24.  
For detailed specifications please see pages 24-27.

### FEATURES

- Natural gas
- Ceramic glass
- Log set with embers
- Fire grate
- Black brick panel floor
- Variable speed blower
- Proflame II GTMF remote control
- Electronic Ignition
- Flame height adjustment control
- Limited lifetime warranty

### OPTIONS

- Arch surround in black with integrated safety screen
- Brick panels in various colors and designs
- Double door inlay
- Wall thermostat
- Propane conversion kit
- Heat Wave™ power duct kit
- AstroCap® venting system
- Steel stud framing kit



# FIREPLACE OPTIONS

## MAXIMIZING COMFORT AND EFFICIENCY

Regency Fireplaces deliver controllable heating solutions by combining the latest in radiant/convection heat technology and innovative features:

- Adjustable flame/heat control.
- Heat radiating ceramic glass.
- **Intelligent Ignition System** features fuel-saving intermittent pilot ignition (IPI), 7-day continuous pilot mode (CPI), and 5 second **Flame Failure Response Time (FFRT)** for more reliable startups - even in cold weather (Electronic Ignition Models Only).
- Power's Out, Heat's On. All Regency gas fireplaces operate without electricity. Enjoy peace of mind all winter long.
- Variable speed blower to maximize efficiency. Our **quiet blowers** increase the efficiency of your fireplace by pushing the heat produced by your fireplace forward and distributing it throughout the room.
- **Proflame GTMF Remote Controls**. A standard feature included with all Traditional Gas Fireplaces, this user friendly programmable remote can be set to start your Regency fire at your desired room temperature and be easily adjusted with the touch of a button.

## COOL WALL SYSTEM

Our patented Cool Wall System utilizes natural convection and innovative design to maintain cool wall surface temperatures without any loss in efficiency or need for fans or additional ducting. The fireplace draws in cooler air from floor level, heating and then distributing the air both in front of the fireplace and at ceiling level, enabling total flexibility in finishing materials and placement of televisions and artwork.



## NO CHIMNEY? NO PROBLEM!

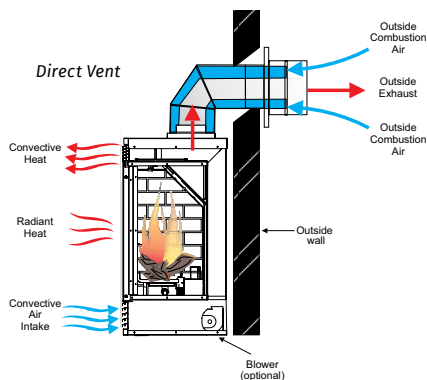

**DIRECT VENT TECHNOLOGY** allows you to add a fireplace to rooms with no existing chimney. Simply vent your fireplace through an outside wall and finish it with the patented **Regency AstroCap Flex Venting System**.

Direct Vent fireplaces are airtight systems that use outside air for combustion, helping maintain indoor air quality and keeping all the warmth generated from your fireplace inside your home. Even when the fireplace is turned off, the sealed system will prevent cold air from entering the home and warm air from leaving. Direct Vent fireplaces allow versatility in **installation and increase fireplace efficiency**.

## SPREAD THE WARMTH

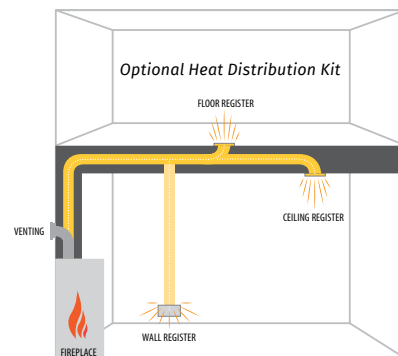

**ZONE HEATING WITH REGENCY:** Add a fireplace to your most frequently used living space and save energy by only heating rooms you use.

**HEAT ADJACENT ROOMS WITH THE HEAT WAVE™ - POWER DUCT SYSTEM:** Cut down on your heating costs using a Heat Wave kit. The Heat Wave system attaches onto most Regency gas fireplaces allowing you to direct heat into rooms up to 20 feet away. This kit comes complete with vent, variable speed blower (for Heat Wave system only) and vent register.

# DESIGN CHOICES

## UNIT SIZE COMPARISON



P33CE



P33/P33E



P36/P36E/P36D



G600EC/G600C



B36XTCE



G800EC/G800C



B41XTCE

## INNER PANEL OPTIONS (NOT AVAILABLE ON ALL MODELS)



Herringbone - Rustic Brown



Standard - Rustic Brown



Standard - Old Town Red



Standard - Charcoal



Castlestone



Ledgestone



Black Enamel Panels



Ember upgrade package

# DESIGN CHOICES

## VIGNETTE FACEPLATE OR LOUVERED OPTIONS

FOR UNITS: P33, P33E, P36, P36E, P36D

### VIGNETTE FACEPLATES & DOOR INLAY



Shown with black Vignette Faceplate, Tuscan Sunset Door Inlay & Vignette finishing trim.

- ① Vignette Faceplate
- ② Vignette Inlay

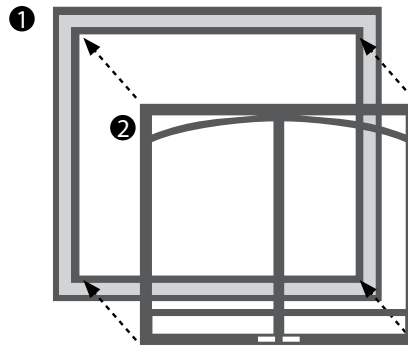

### VIGNETTE FACEPLATES & INLAYS FINISHES



Black



Black Chrome



Platinum  
(Not available for inlays)



Tuscan Sunset

### LOUVERS



Black Louvers  
For units: P33/P33E/P36/P36E/P36D

# ACCESSORIES OPTIONS

## GRANDVIEW UNITS (G800EC, G800C, G600EC, G600C)

ACCESSORIES		G800EC • G600EC ELECTRONIC IGNITION	G800C • G600C STANDING PILOT
Safety Screen		✓	✓
Ceramic Glass		✓	✓
Proflame II Remote Control		✓	•
On/Off Remote		•	★
Accent & Emberbed Lights		✓	•
Inner Panels	Black	★	★
	Standard - Volcanic Black	★	★
	Standard - Rustic Brown	★	★
	Castlestone	★	★
	Herringbone	★	★
	Black Enamel	★	★
Faceplates	Black	★	★
	Brushed Nickel	★	★
	Antique Copper	★	★
Finishing Trims	Clean Front	★	★
	Outside Finish	★	★
Media	Driftwood Logs	★	★
	Birch Logs	★	★
	Oak Logs	★	★
	Crushed Glass (Various Colors)	★	★
Blower (with Fan Speed Control)		★	★
Propane Conversion Kit		★	★

- Not available
- ✓ Standard
- ★ Optional

## REMOTES & THERMOSTATS



Proflame I GTMF Remote Control



Proflame II GTMF Remote Control



Programmable Thermostat

FEATURE	DESCRIPTION	PROFLAME GTMF	PROGRAMMABLE THERMOSTAT
On/Off		✓	✓
Child lock		✓	•
LCD Backlit Screen		✓	✓
Clock		•	✓
Temperature display	°F / °C	✓	✓
Thermostat	one setting (all days)	✓	✓
	5-day weekday & 2-day weekend	•	✓
Smart thermostat*		✓	•
Flame adjustment	(6 levels)	✓	•
Fan control**	(6 levels)	✓	•
Accent light (On/Off)***		✓	•

\* Smart Thermostat - Rather than a thermostat that simply turns your fireplace on and off, the Smart Control function allows you to set your desired room temperature. As the room reaches your personal setting the flame intensity and heat will gradually decrease - keeping the ambience of your Regency fire on with less heat output with the option to turn off at any time.

\*\* For models that have a blower.

\*\*\* For models that have an optional accent light.

# ACCESSORIES OPTIONS

ACCESSORIES - AT A GLANCE		B41XTCE	B36XTCE	P90E	P36/ P36D	P36E	P33CE	P33E	P33	
Clean front	Glass	✓	✓	•	•	•	✓	•	•	
Faceplates	Vignette	Black	•	•	•	★	★	•	★	★
		Black Chrome	•	•	•	★	★	•	★	★
		Platinum	•	•	•	★	★	•	★	★
		Tuscan Sunset	•	•	•	★	★	•	★	★
	Vignette Door Inlay	Black	•	•	•	★	★	•	★	★
		Black Chrome	•	•	•	★	★	•	★	★
		Tuscan Sunset	•	•	•	★	★	•	★	★
Vignette Finishing trim		•	•	•	★	★	•	★	★	
Surrounds	Metal	Black	•	•	•	•	•	★	•	•
		Stainless Steel	•	•	•	•	•	★	•	•
		Sunset Bronze	•	•	•	•	•	★	•	•
	Glass	Pure Black	•	•	•	•	•	★	•	•
		Chocolate	•	•	•	•	•	★	•	•
Excaltibur Arch Surrounds	Surround	Black	•	•	★	•	•	•	•	
	Door Inlay	Black	•	•	★	•	•	•	•	
Classic look	Louvers	Black	•	•	•	★	★	•	★	★
	Flush panels	Black	•	•	•	•	•	•	•	
	Finishing Trim	Black	•	•	•	★	★	•	★	★
Inner panels	Bricks	Standard - Rustic Brown	★	★	★	★	★	★	★	★
		Standard - Old Town Red	★	★	★	★	★	★	★	★
		Standard - Charcoal	★	•	•	•	•	•	•	•
		Herringbone - Rustic Brown	•	•	★	★	★	★	★	★
		Castlestone	★	★	•	•	•	•	•	•
	Ledgestone	•	•	•	•	•	•	•	•	
Reflective	Black enamel	★	★	•	★	★	★	★	★	
Safety Screen (included with unit or faceplate)		✓	✓	✓	✓	✓	✓	✓	✓	
Ember upgrade package		★	★	★	★	★	★	★	★	
Blower (with fan speed controller)		★	★	✓	★	★	★	★	★	
Controls	Programmable Thermostat	★	★	★	★	★	★	★	★	
	Proflame GTMF Remote Control	✓	✓	✓	✓	✓	✓	✓	✓	
	Proflame GTMFS Remote Control	•	•	•	•	•	•	•	•	
Venting	Direct vent	✓	✓	✓	✓	✓	✓	✓	✓	
	AstroCap® Venting System	★	★	★	★	★	★	★	★	
	Heat Wave™ Power Duct System	•	•	★	★	★	★	★	★	
Propane conversion kit		•	★	★	★	★	★	★	★	

- Not available
- ✓ Standard
- ★ Optional

# GRANDVIEW SPECIFICATIONS

## INSTALLATION OPTIONS (G800EC, G800C, G600EC, G600C)

### Non-Combustible Finishing Install

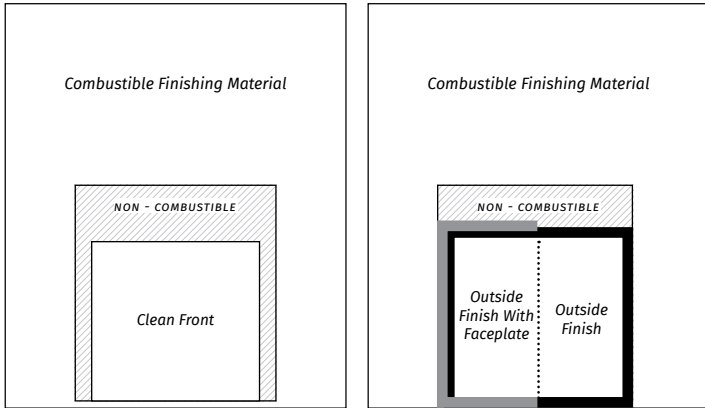

### Combustible Finishing Install with Cool Wall

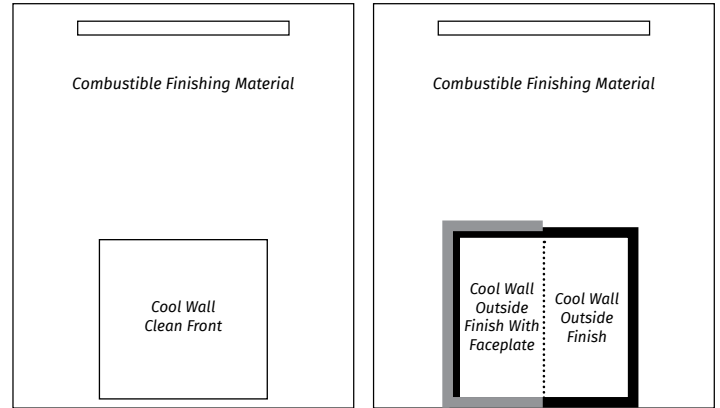

## DIMENSIONS - G800EC, G800C

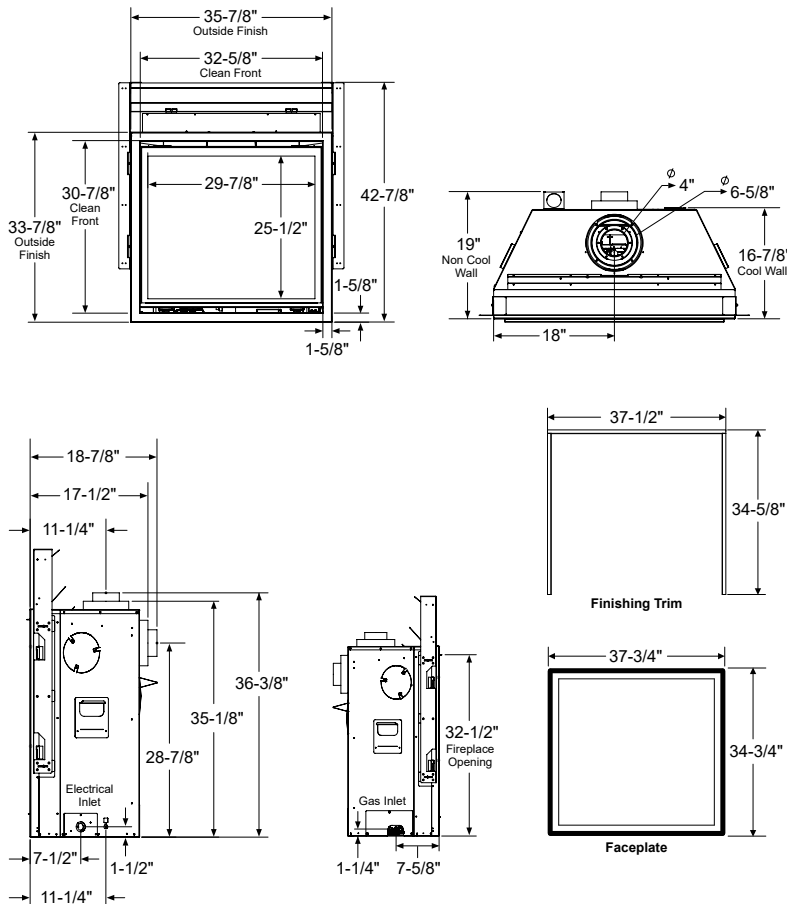

NOTE: For full latest up to date installation and clearances details, please always refer to the manual.

## FRAMING - G800EC, G800C

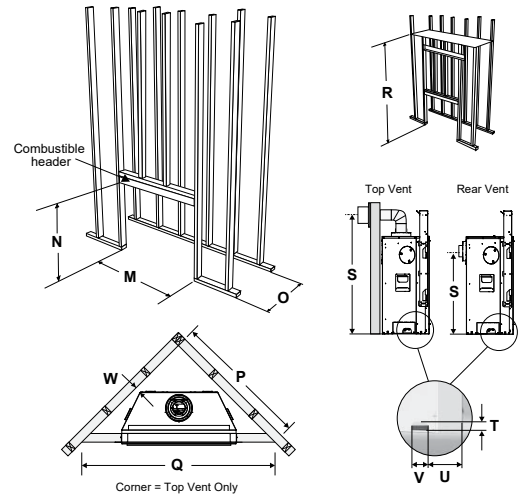

IMPORTANT: Corner applications are vented from the top only - rear venting cannot be used.

FRAMING		COOL WALL	CLEAN FRONT	OUTSIDE FINISH
M	Framing Width	36-1/2"	37-1/2"	36-1/2"
N*	Framing Height	43"	43"	43"
O	Framing Depth	16-7/8"	19-1/4"***	19-1/4"***
P	Corner Facing Wall Width	42-1/2"	61-1/4"***	46-1/2"***
Q	Corner Facing Wall Width	60"	86-5/8"	65-3/4"
R	Framed Chase Ceiling Enclosure	80"	62"	62"
S	Vent Centerline Height - Rear	29"	29"	29"
S	Vent Centerline Height - Top	44"	44"	44"
T	Gas Connection Height	1-1/2"	1-1/2"	1-1/2"
U	Gas Connection Inset	6-3/8"	6-3/8"	6-3/8"
V	Gas Connection Width	3"	3"	3"
W	Clearance to Corner of Unit	2-3/4"	2-3/4"	2-3/4"
	Non-combustible Material Required Above Appliance	--	11-1/2"	10"

\* Important: Framing height requires consideration of the hearth depth.

Dimension N = N + the thickness of the installed hearth.

\*\* Top Vent Only

# GRANDVIEW SPECIFICATIONS

## DIMENSIONS - G600EC, G600C

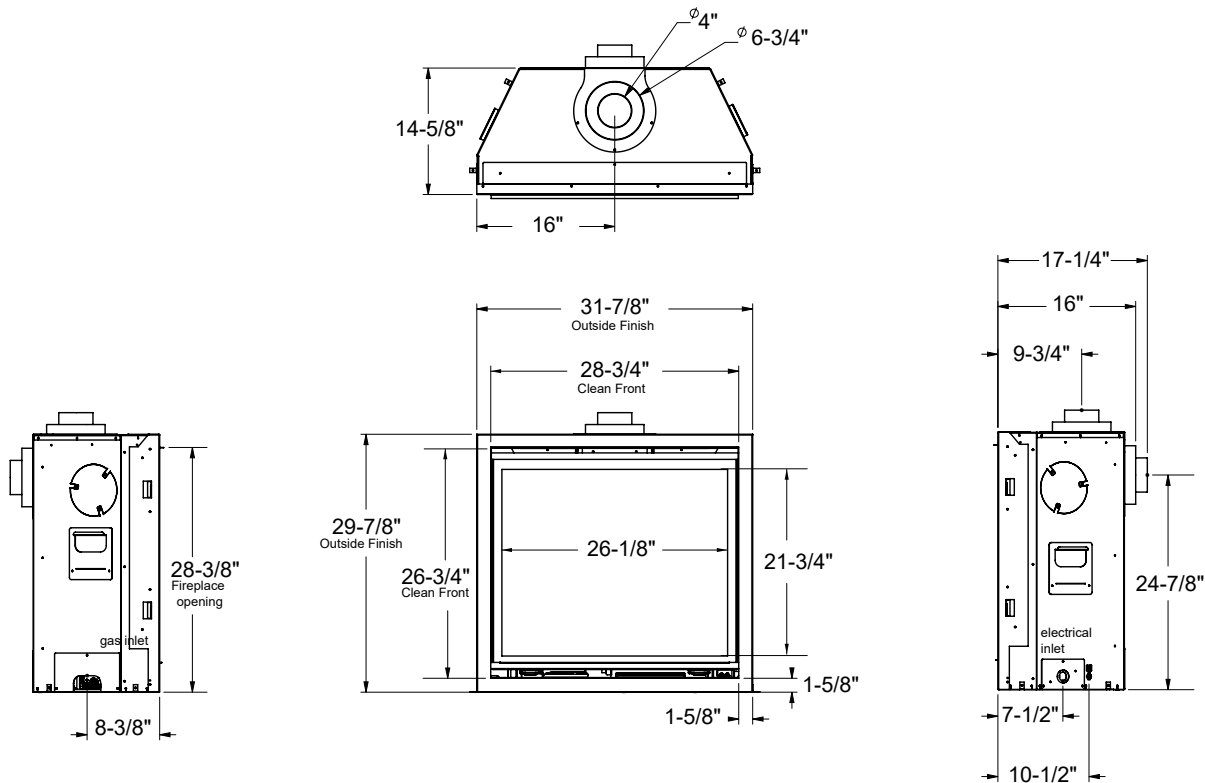

NOTE: For full latest up to date installation and clearances details, please always refer to the manual.

## FRAMING - G600EC, G600C

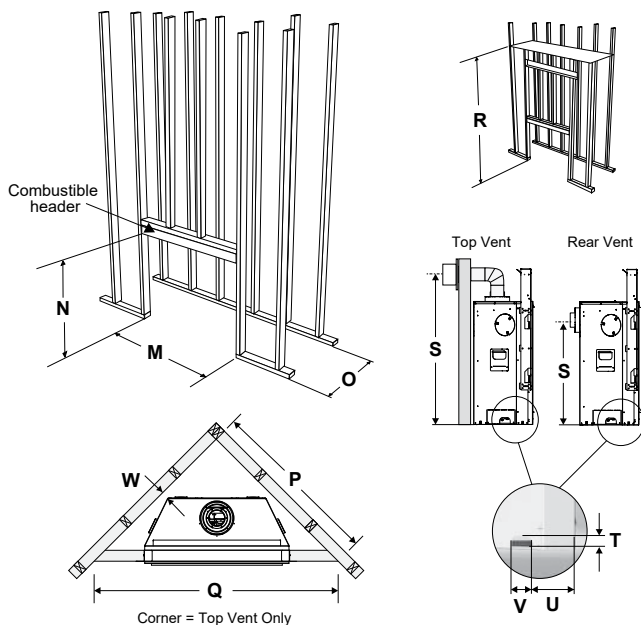

FRAMING	COOL WALL	CLEAN FRONT	OUTSIDE FINISH
M Framing Width	33"	33-1/2"	33-1/2"
N* Framing Height	40"	40"	40"
O Framing Depth	15"	16-3/4"	16-3/4"
P Corner Facing Wall Width	37-1/4"	40"	40"
Q Corner Facing Wall Width	52-1/2"	57"	57"
R Framed Chase Ceiling Enclosure - Rear	74-1/2"	43-1/2"	43-1/2"
R Framed Chase Ceiling Enclosure - Top	74-1/2"	60"	60"
S Vent Centerline Height - Rear	24-7/8"	24-7/8"	24-7/8"
S Vent Centerline Height - Top	40"	40"	40"
T Gas Connection Height	1-7/8"	1-7/8"	1-7/8"
U Gas Connection Inset	8-3/8"	8-3/8"	8-3/8"
V Gas Connection Width	3-1/2"	3-1/2"	3-1/2"
W Clearance to Corner of Unit	1/2"	2"	2"
Non-combustible Material Required Above Appliance	no	yes	yes

\* Important: Framing height requires consideration of the hearth depth. Dimension N = N + the thickness of the installed hearth.

\*\* Top Vent Only

# SPECIFICATIONS

SPECIFICATIONS - PROPANE		INPUT (BTU)	TURN DOWN TO (BTU)	EFFICIENCY (STEADY STATE)	ENERGUIDE RATING (CANADA ONLY)
Bellavista	B41XTCE	37,500	29,500	72.63%	68.35%
	B36XTCE	31,000	25,000	71.08%	65.90%
Panorama	P36D	30,000	15,000	71.26%	63.89%
	P36	30,000	15,000	70.55%	62.36%
	P36E	28,500	22,000	74.40%	67.44%
	P33	18,000	14,500	74.06%	67.92%
	P33E	19,500	15,500	73.82%	69.44%
	P33CE	19,500	15,500	73.82%	69.44%
Excalibur	P90E	31,500	25,500	76.86%	72.79%

## EXCALIBUR P90E

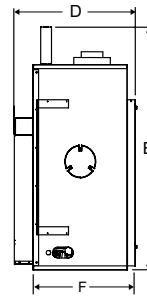
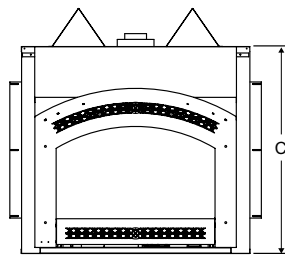
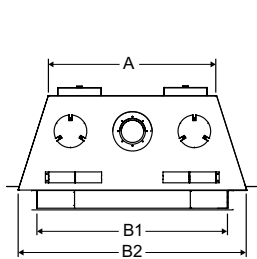

	P90E
A	31"
B1	35-1/8"
B2	42"
C	38"
D*	22-1/2"
E	45"
F	19-1/8"

\* Without faceplate

For installation, framing and clearances see manuals on our website: [www.regency-fire.com](http://www.regency-fire.com)

NOTE: All product specifications are subject to change without notice. Before installing refer to the relevant product manual for full and up-to-date information.



# SPECIFICATIONS

## PANORAMA DIRECT VENT FIREPLACES

P36D  
P36E  
P36

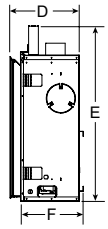
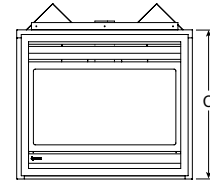
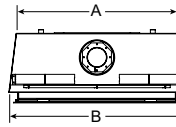

P33  
P33E

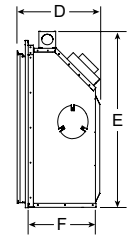
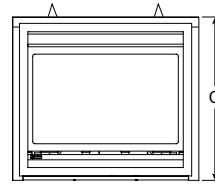
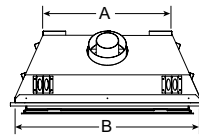

P33CE

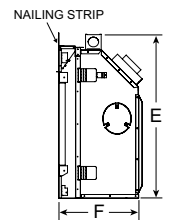
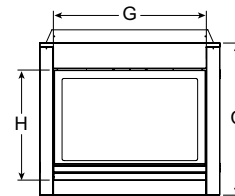
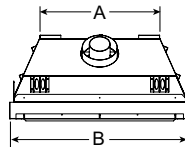

	P36D	P36E/ P36	P33E/P33	P33CE
A	33-1/16"	33-1/8"	23"	23"
B	36-1/16"	36-1/16"	33"	34-9/16"
C	30-1/2"	14-3/4"	14-1/2"	29-1/4"
D*	19-1/8"	15"	14-3/4"	--
E	36"	36"	31-1/2"	31-3/4"
F	17-1/8"	12-3/4"	12-3/4"	16"
G	--	--	--	29-7/16"
H	--	--	--	21-3/8"

\* Includes Vignette faceplate  
See manual for Vignette finishing trim dimensions

## BELLAVISTA DIRECT VENT FIREPLACES

B41XTCE/  
B36XTCE

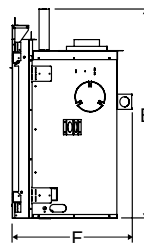
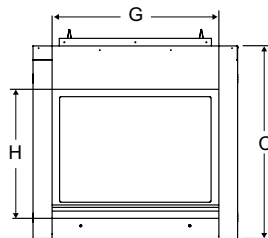
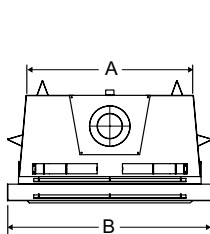

	B41XTCE	B36XTCE
A	38-3/8"	33-1/16"
B	46-11/16"	40-5/8"
C	44-1/4"	38-1/16"
D*	--	--
E	49-1/2"	41-5/16"
F	26-3/16"	23-5/8"
G	38-7/16"	32-7/8"
H	29-1/8"	25-5/8"

\* Includes Vignette Faceplate

For installation, framing and clearances see manuals on our website: [www.regency-fire.com](http://www.regency-fire.com)

NOTE: All product specifications are subject to change without notice. Before installing refer to the relevant product manual for full and up-to-date information.

# SPECIFICATIONS

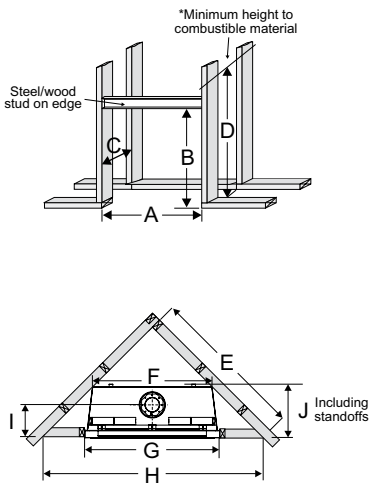

## P36/P36E/P36D

INSTALLATION	UNITS	A	B	C	D*	E	F	G	H	I	J
Framing with Vignette Faceplate Stepped Finish	P36/P36E	36-1/4"	40-3/4"	12-3/4"	46"	42-7/16"	33-1/4"	36-1/4"	60"	7-1/4"	12-3/4"
	P36D	36-1/4"	40-3/4"	17-3/8"	46"	48"	33-1/4"	36-1/4"	68"	11-1/4"	17-1/8"
Framing with Vignette Faceplate & Finishing Trim Finished Flush	P36/P36E	38"	41-5/8"	14-3/4"	46"	43-11/16"	33-1/4"	38"	61-13/16"	9-1/4"	14-3/4"
	P36D	38"	41-5/8"	19-3/8"	46"	50-9/16"	33-1/4"	38"	71-9/16"	13-1/4"	-
Framing with Louvers and safety screen	P36/P36E	36-1/4"	36-1/4"	12-3/4"	46"	42-7/16"	33-1/4"	36-1/4"	60"	7-1/4"	12-3/4"
	P36D	36-1/4"	37-1/4"	17-3/8"	46"	48"	33-1/4"	36-1/4"	68"	11-1/4"	17-1/8"

\* 'D' is minimum height to combustible materials including the minimum 2" top clearance to the horizontal vent.

## P90E

INSTALLATION	UNIT	A	B	C	D	E	F	G	H	I	J
Framing and Finishing	P90E	46-1/2"	45-1/4" 46-3/8"	21-1/2"	53-3/4"	51-1/8"	31"	46-1/2"	72-1/4"	13-11/16"	19-1/4"

\* If raised 1-1/8" using base standoffs.

## P33/P33E

**VERTICAL TERMINATION OR VERTICAL RISE WITH HORIZONTAL TERMINATION**  
Vignette and Vignette Finishing Trim - Finished Flush

For Both Rigid & Flex

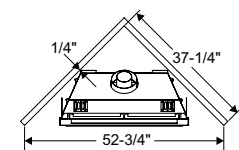
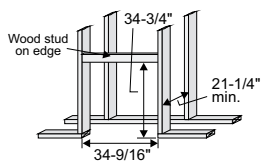

**VERTICAL TERMINATION OR VERTICAL RISE WITH HORIZONTAL TERMINATION**  
Vignette and Vignette Finishing Trim Stepped Finish or Safety Screen and Louvers

For Both Rigid & Flex

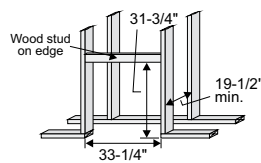

**REAR TERMINATION**  
Vignette and Vignette Finishing Trim - Finished Flush

For Rigid Vent

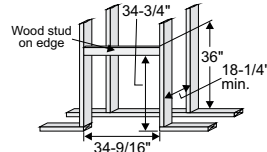

For Flex Vent

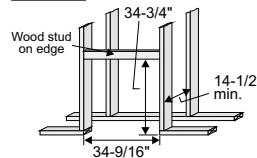

For Both Rigid & Flex

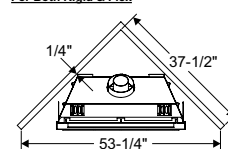

**REAR TERMINATION**  
Vignette and Vignette Finishing Trim Stepped Finish or Safety Screen and Louvers

For Rigid Vent

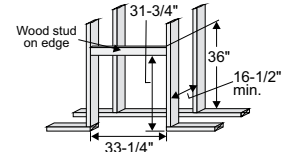

For Flex Vent

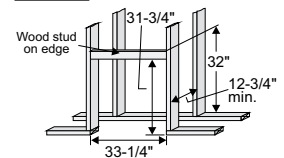

For Both Rigid & Flex

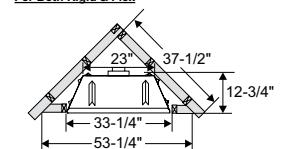

For installation, framing and clearances see manuals on our website: [www.regency-fire.com](http://www.regency-fire.com)

NOTE: All product specifications are subject to change without notice. Before installing refer to the relevant product manual for full and up-to-date information.

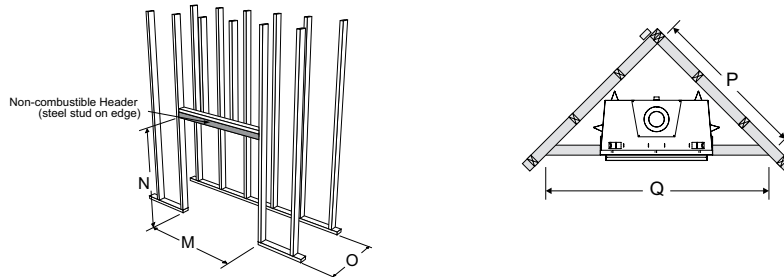

### B41XTCE

INSTALLATION	M	N	O (REAR VENT)	O (TOP VENT)	P	Q
Framing	47-1/4"	49-1/2"	26-1/2"	25-7/8"	65-1/4"	91-11/16"

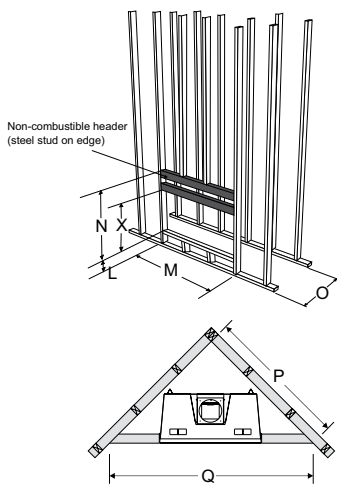

### B36XTCE

FRAMING	B36XTCE
L	0"
M	41-1/4"
N	46-3/4"
O (Rear Vent)	23-7/8"
O (Top Vent)	23-7/8"
P (Rear Vent)	57-7/8" AstroCapXL 66-1/8" other approved caps
P (Top Vent)	53-1/4"
Q (Rear Vent)	81-1/2" AstroCapXL 93-1/2" other approved caps
Q (Top Vent)	75-1/4"
X	41" (Optional steel stud)

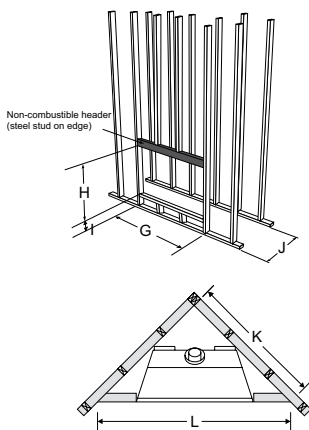

### P33CE

FRAMING	P33CE WITH NON-COMBUSTIBLE BOARD ONLY	P33CE WITH TILE, STONE, BRICK, SLATE, VERONA SURROUND OR OTHER NON-COMBUSTIBLE FINISH
G	35"	35"
H	31-3/4"	31-3/4"
I	0" (when not using a surround)	0" 3-5/16" min (w/ verona surround)
J	23-1/4" Vertical Rise 20-1/4" Rigid 16-1/2" Flex	22-3/4" Vertical Rise 19-3/4" Rigid 16" Flex
K	39-1/4"	38-15/16"
L	55-1/2"	54-1/2"

For installation, framing and clearances see manuals on our website: [www.regency-fire.com](http://www.regency-fire.com)

NOTE: All product specifications are subject to change without notice. Before installing refer to the relevant product manual for full and up-to-date information.



[regency-fire.com](http://regency-fire.com)

*your Regency dealer*

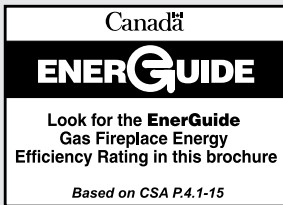

©2021 FPI Fireplace Products International Ltd. Regency®, Panorama®, Excalibur®, Bellavista®, SureFire®, Heat Wave™, Heat Release™, and AstroCap™ are registered or proprietary trademarks of FPI Fireplace Products International Ltd. All rights reserved. Printed in Canada (07/21) Part no. 944-227